

# **KTM** POWERPARTS **INFORMATION**

SKID PLATE

50403990000  
55403990000  
55503990000  
79003990000  
79403990000  
50403990544  
55403990544  
55503990544  
79003990544  
79403990544

10.2018  
3.213.450



KTM Sportmotorcycle GmbH  
5230 Mattighofen, Austria  
www.ktm.com



## 3 DEUTSCH

Wir freuen uns, dass Sie sich für dieses Produkt entschieden haben.

Unser hochwertiges Qualitätsprodukt ist rennerprobt und wurde speziell für sportliche Herausforderungen entwickelt. Eine korrekte Montage des Produktes ist unerlässlich, um ein Maximum an Sicherheit und Funktionalität gewährleisten zu können. Bitte befolgen Sie daher die Montageanleitung oder wenden Sie sich an Ihren autorisierten Fachhändler.

**Für falsche Montage oder Verwendung dieses Produktes kann der (Quasi-)Hersteller bzw. Lieferant nicht zur Verantwortung gezogen werden.**  
Vielen Dank.

## 5 ENGLISH

Thank you for choosing this product.

Our high quality product has been tested under racing conditions and was developed specifically for use in sports activities. Correct installation of the product is essential to ensure that a maximum degree of safety and functionality is achieved. Therefore, please follow the installation instructions or contact your authorized dealer.

**The (quasi) manufacturer or supplier cannot be held responsible for products that are incorrectly mounted or inappropriately used.**  
Thank you.

## 7 ITALIANO

Grazie per aver scelto questo prodotto.

Questo nostro prodotto di pregiata qualità è collaudato nelle competizioni ed è stato sviluppato specificamente per gare sportive. Il montaggio corretto del prodotto è fondamentale per garantirne la massima sicurezza e funzionalità. Rispetti quindi le istruzioni di montaggio o rivolgerti al proprio concessionario autorizzato.

**Il produttore (detentore del marchio)/fornitore non può essere considerato responsabile per un montaggio o impiego errato del presente prodotto.**  
Vi ringraziamo per l'attenzione!

## 9 FRANÇAIS

Merci d'avoir porté votre choix sur ce produit.

Notre produit de haute qualité est éprouvé pour les compétitions et a été conçu spécialement pour un usage sportif. Un montage approprié du produit est indispensable pour garantir une sécurité et une fonctionnalité maximales du véhicule. C'est pourquoi nous vous invitons à suivre scrupuleusement le manuel de montage ou à vous adresser à votre revendeur agréé.

**En cas de montage ou d'utilisation non conformes de ce produit, le (quasi) constructeur ou le fournisseur déclinent toute responsabilité.**  
Merci !

## 11 ESPAÑOL

Le agradecemos que se haya decidido por este producto.

Este producto de alta calidad está probado para la competición y se ha desarrollado específicamente para las exigencias de este deporte. Para poder garantizar los máximos niveles de seguridad y funcionalidad, es imprescindible que el producto se monte correctamente. Por este motivo, es muy importante que siga las instrucciones del manual de montaje o que se ponga en contacto con su concesionario autorizado.

**El (cuasi) fabricante y el proveedor de este producto no se harán responsables del montaje y el uso incorrectos.**  
¡Muchas gracias!

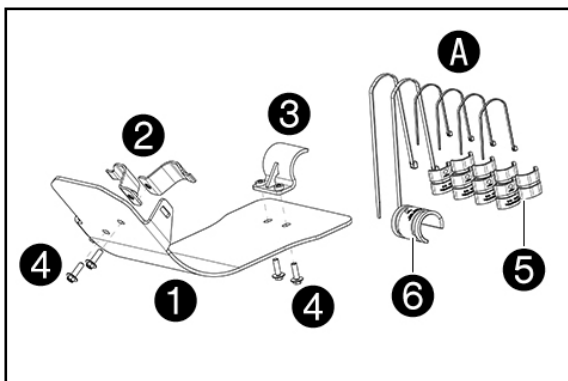

### Lieferumfang

- 1x Motorschutz Grundplatte ❶
- 2x Halteblech ❷
- 1x Lasche ❸
- 4x Schraube M6x20 ❹
- 1x Gummipuffer Kit ❶
- 4x kleine Gummipuffer ❺
- 1x großer Gummipuffer ❻

### HINWEIS

Ein Helfer ist für diese Arbeit sinnvoll.

### Vorarbeit

- Motorschutz ❶ (Lieferumfang) positionieren.
- Position für Gummipuffer links und rechts mit einem Stift markieren ❷.

### HINWEIS:

Die Gummipuffer dienen als Auflage für den Motorschutz und als Unterlage für die Haltebleche.

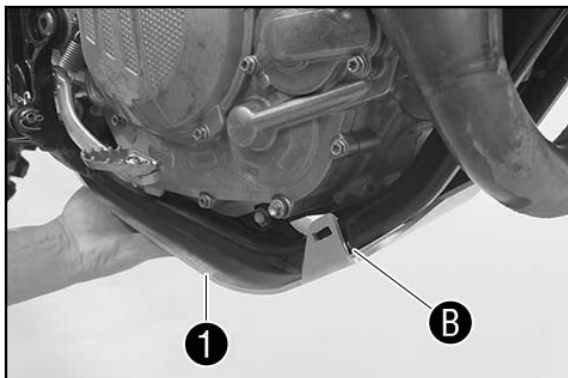

### Montage

- Kleine Gummipuffer ❺ mit kleinen Kabelbindern (alles Lieferumfang ❶) am Rahmen vorn montieren.

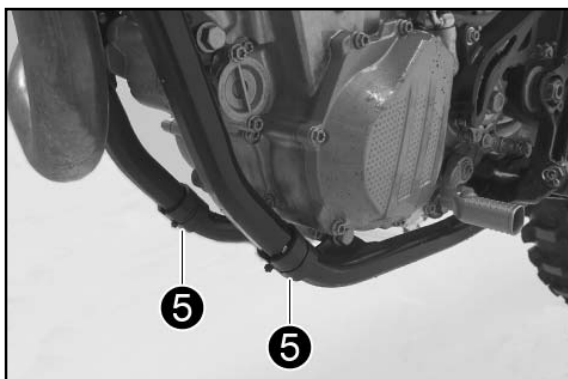

- Kleine Gummipuffer ❺ mit Kabelbindern (alles Lieferumfang ❶) am Rahmen hinten montieren.

### HINWEIS:

Der Gummipuffer kann hier zweigeteilt werden, da er nur als Auflage für den Motorschutz dient.

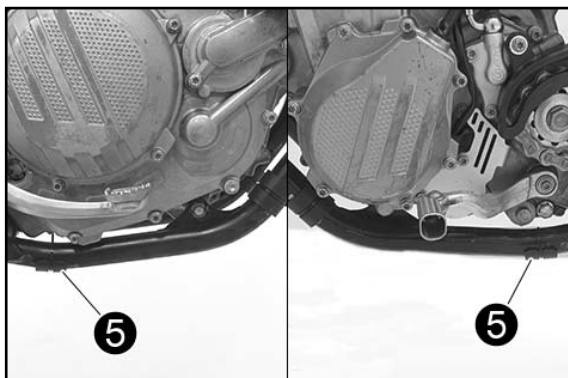

- Großen Gummipuffer ❻ mit großen Kabelbindern (alles Lieferum-fang ❶) an Querstrebe hinten montieren.

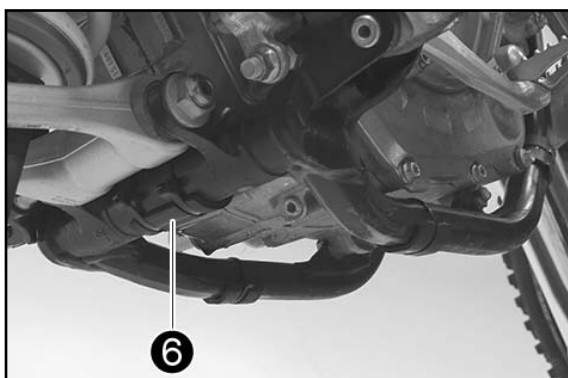

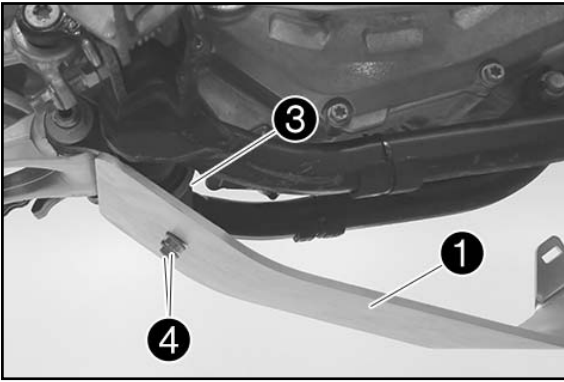

- Motorschutz ① (Lieferumfang) positionieren.
- Lasche ③ (Lieferumfang) auf den Gummipuffer der Querstrebe positionieren.
- Schrauben ④ (Lieferumfang) montieren, aber noch nicht festziehen.

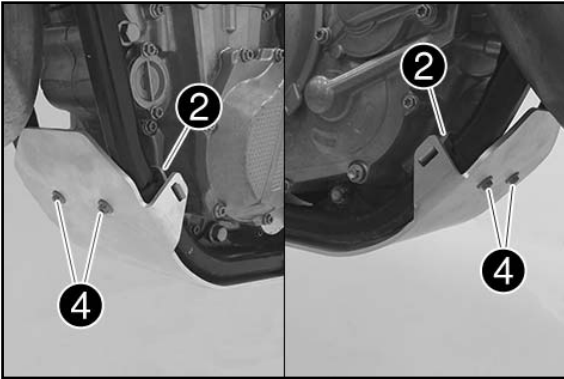

- Halteblech links und rechts ② (Lieferumfang) einhängen und auf den vorderen Gummipuffern positionieren.
- Schrauben ④ (Lieferumfang) montieren und alle mit 10 Nm festziehen.

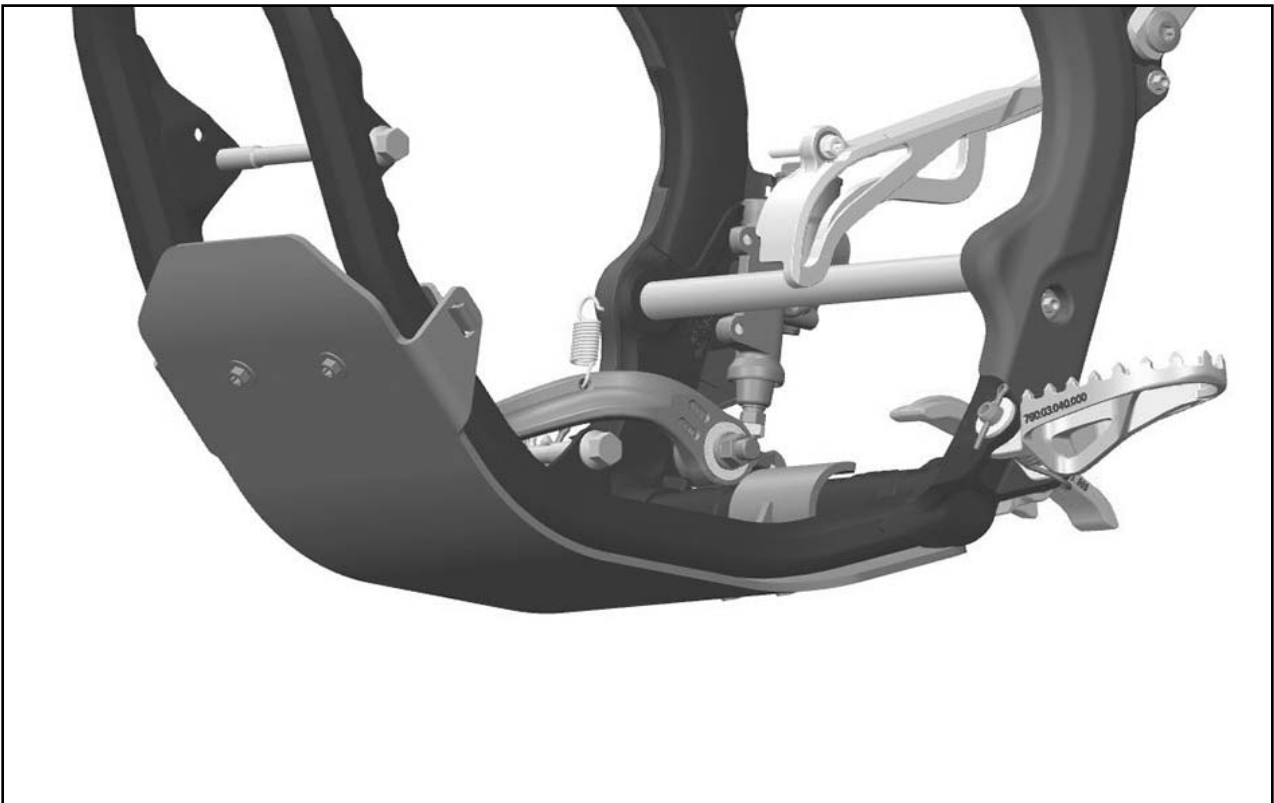

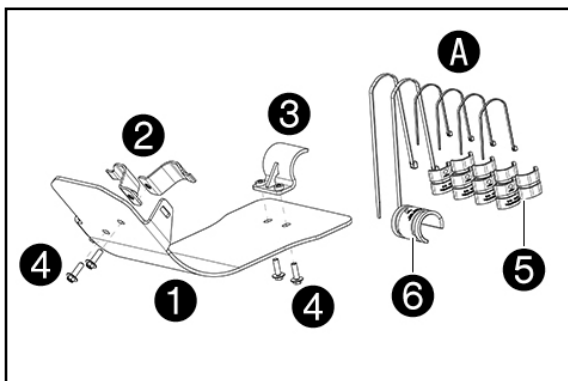

### Scope of supply

- 1x engine guard base plate ❶
- 2x retaining bracket ❷
- 1x catch ❸
- 4x screw M6x20 ❹
- 1x rubber buffer kit ❶
- 4x small rubber buffer ❺
- 1x large rubber buffer ❻

### NOTE:

The help of an assistant is useful for this work.

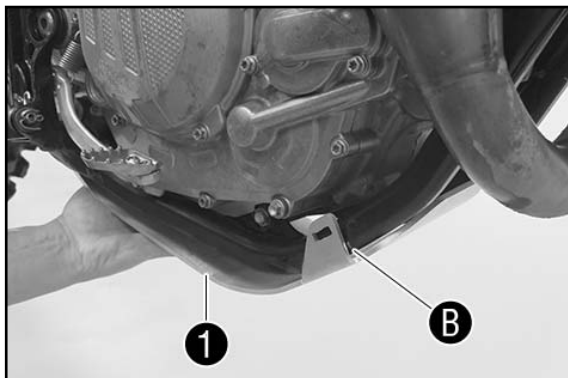

### Preparatory work

- Position engine guard ❶ (included).
- Mark position for rubber buffers left and right with a pen ❷.

### NOTE:

The rubber buffers are used as a support for the engine guard and a lining for the retaining brackets.

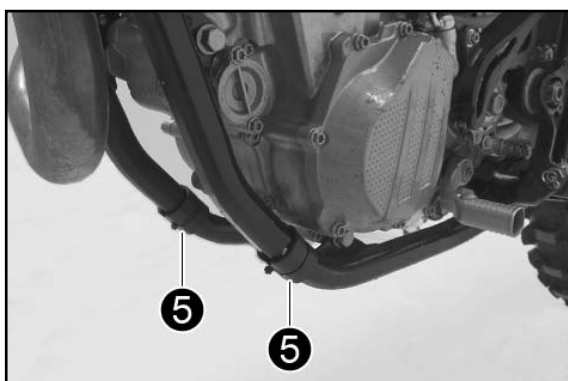

### Assembly

- Mount small rubber buffers ❺ with small cable ties (all included ❶) on the frame at the front.

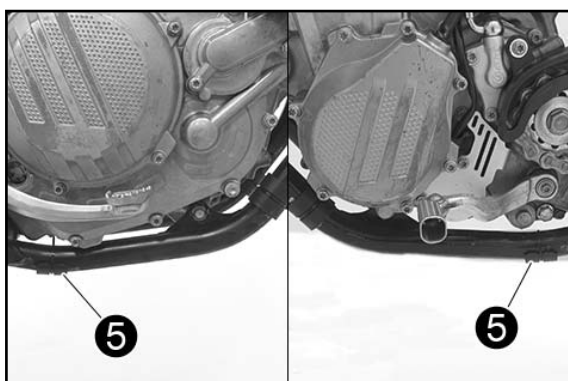

- Mount small rubber buffers ❺ with small cable ties (all included ❶) on the frame at the rear.

### NOTE:

The rubber buffer can be split into two parts here as it is only used as a support for the engine guard.

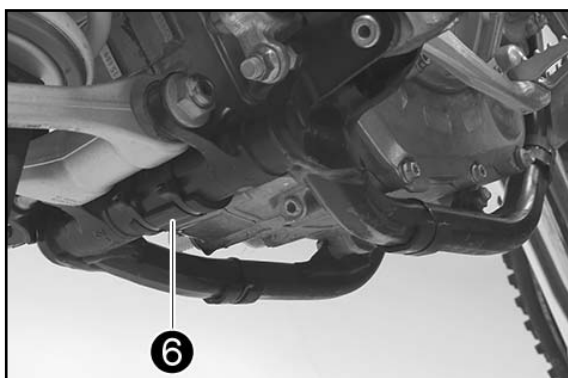

- Mount large rubber buffer ❻ with large cable ties (all included ❶) on the cross member at the rear.

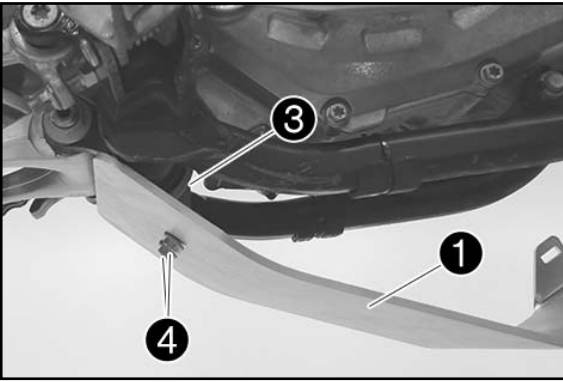

- Position engine guard **1** (included).
- Position catch **3** (included) on the rubber buffer of the cross member.
- Mount screws **4** (scope of supply) but do not tighten them yet.

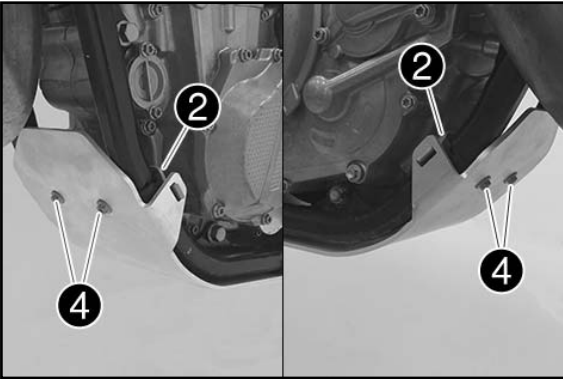

- Attach left and right retaining brackets **2** (included) and position on the front rubber buffers.
- Mount screws **4** (scope of supply) and tighten all to 10 Nm.

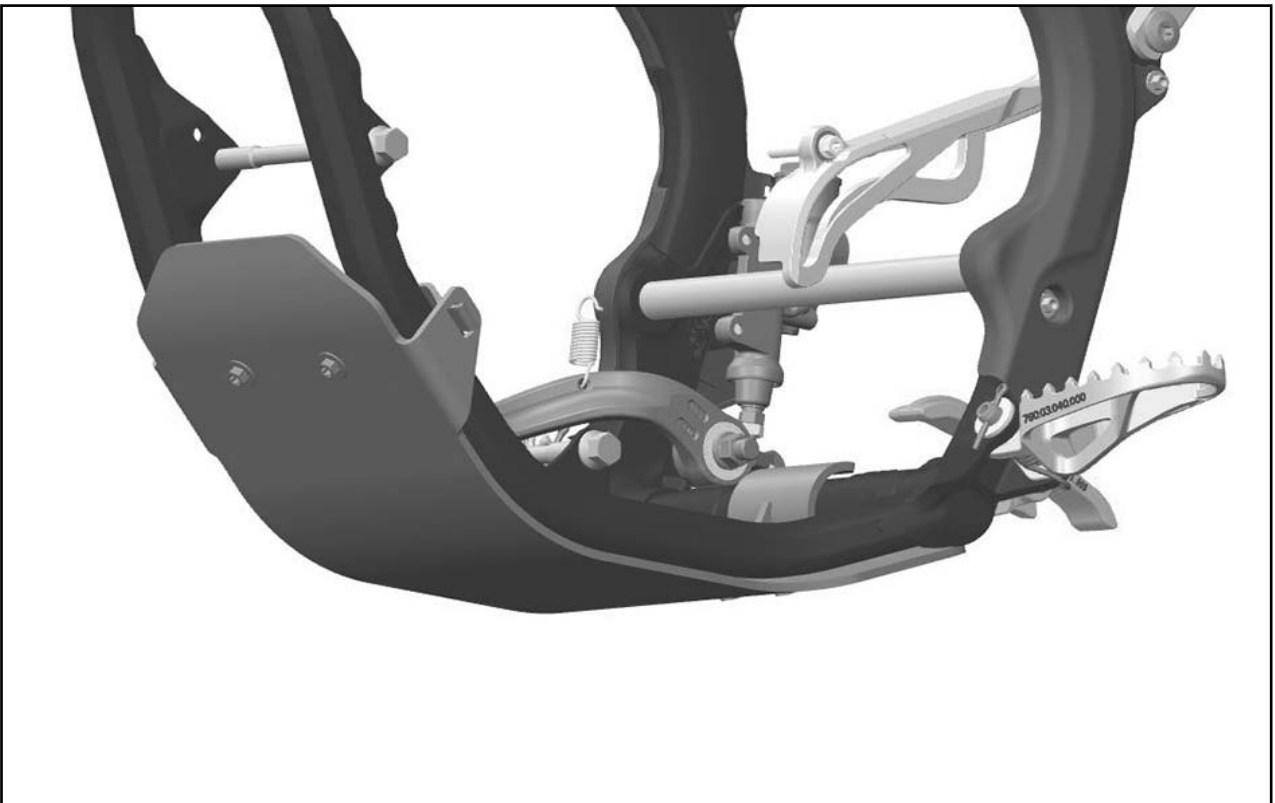

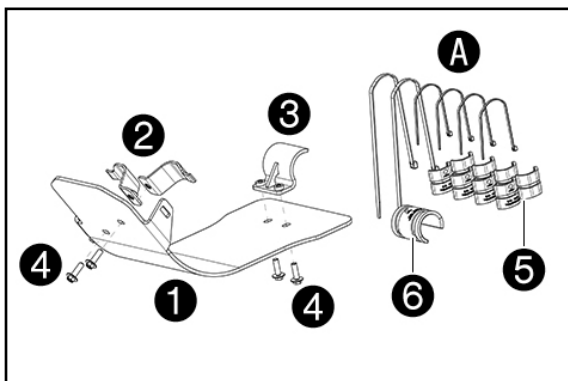

### Materiale fornito

- 1x piastra base per paramotore ❶
- 2x piastrine ❷
- 1x aletta ❸
- 4x viti M6x20 ❹
- 1x kit di tamponi in gomma A
- 4x tamponi in gomma piccoli ❺
- 1x tampone in gomma grande ❻

### AVVERTENZA:

Per questo lavoro è utile farsi aiutare da una seconda persona.

### Operazione preliminare

- Mettere in posizione il paramotore ❶ (in dotazione).
- Segnare la posizione per i tamponi in gomma a sinistra e a destra con una puntina B.

### AVVERTENZA:

I tamponi in gomma servono come base per il paramotore e come sostegno per le piastrine.

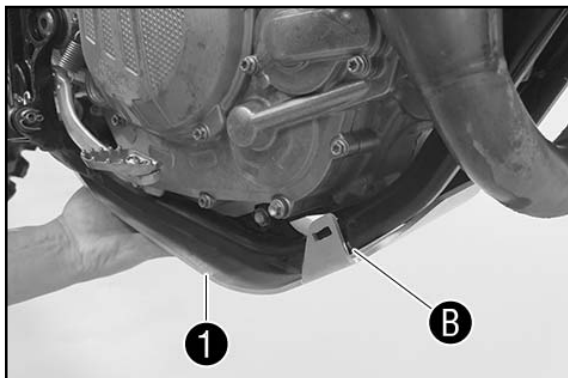

### Montaggio

- Montare davanti sul telaio i tamponi in gomma piccoli ❺ con le fascette serracavi piccole (tutto in dotazione A).

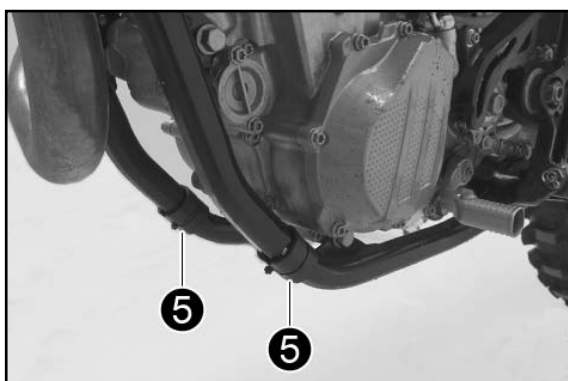

- Montare dietro sul telaio i tamponi in gomma piccoli ❺ con le fascette serracavi (tutto in dotazione A).

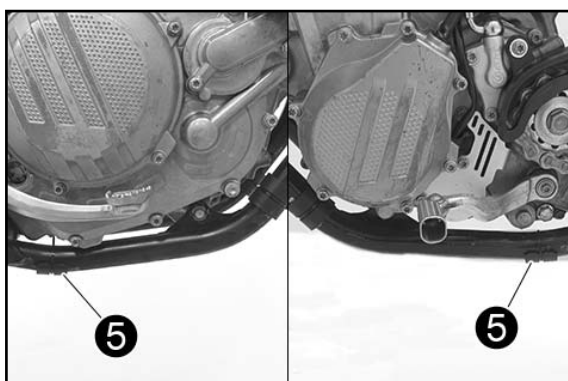

### AVVERTENZA:

Il tampone in gomma qui può essere diviso in due poiché serve solo come base per il paramotore.

- Montare dietro sulla barra trasversale il tampone in gomma grande ❻ con le fascette serracavi grandi (tutto in dotazione A).

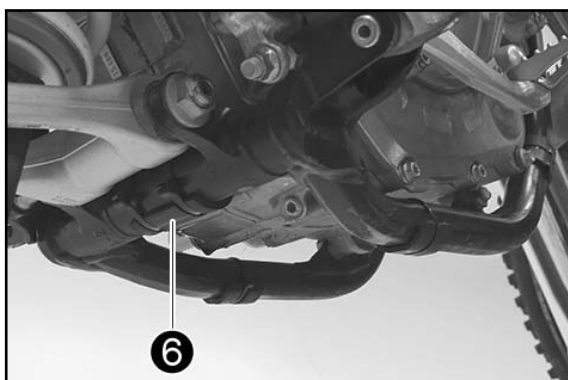

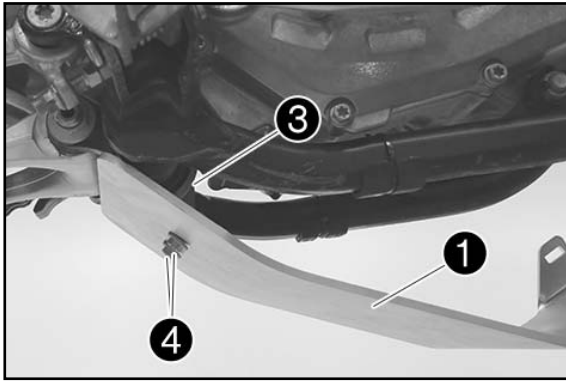

- Mettere in posizione il paramotore ❶ (in dotazione).
- Posizionare l'aletta ❸ (in dotazione) sul tampone in gomma della barra trasversale.
- Montare le viti ❹ (in dotazione), senza però serrarle.

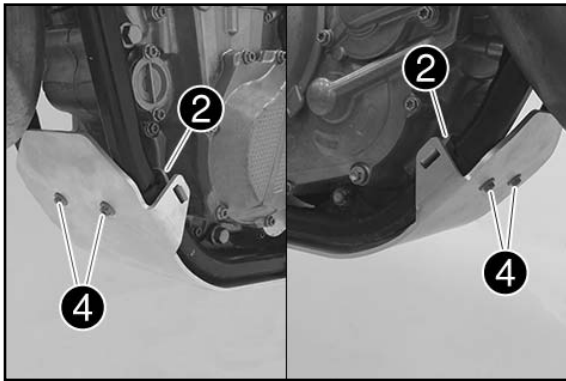

- Appendere la piastrina a sinistra e a destra ❷ (in dotazione) e posizionarla sui tamponi in gomma anteriori.
- Montare le viti ❹ (in dotazione) e serrarle tutte a 10 Nm.

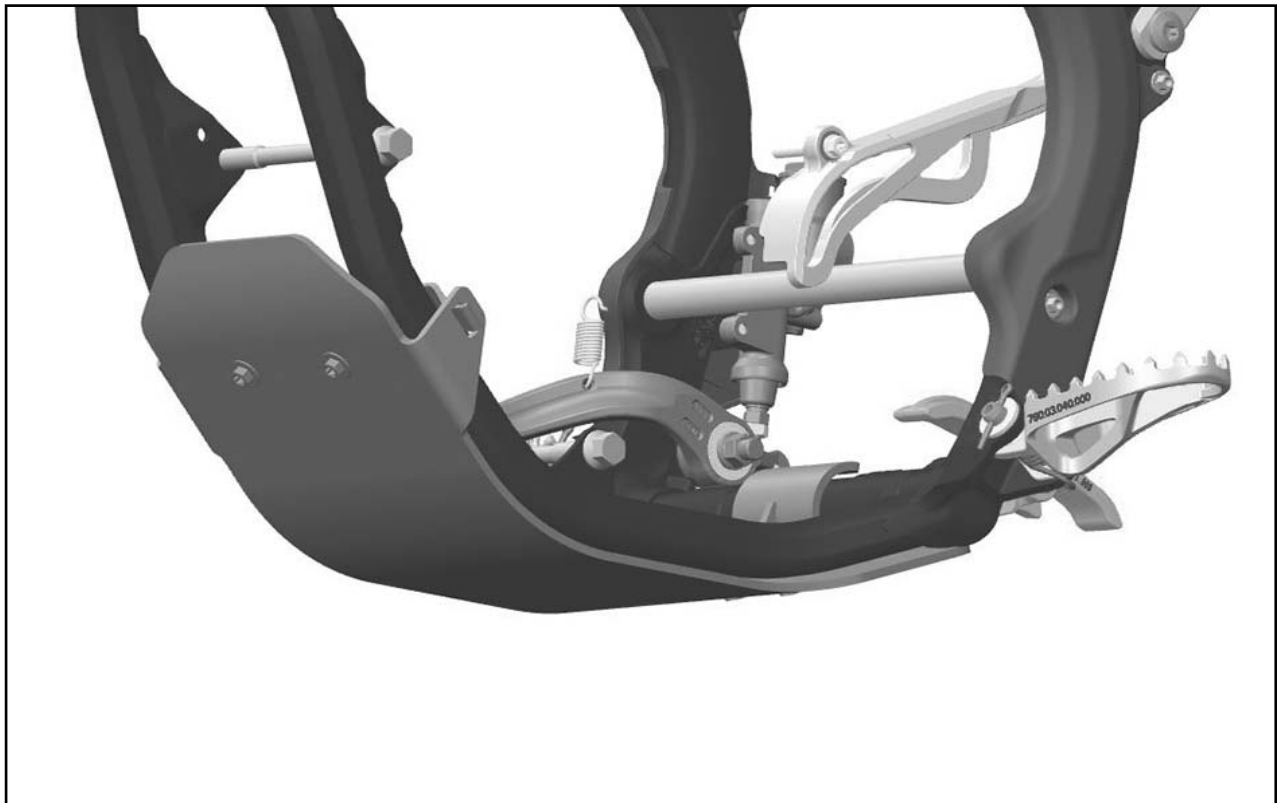



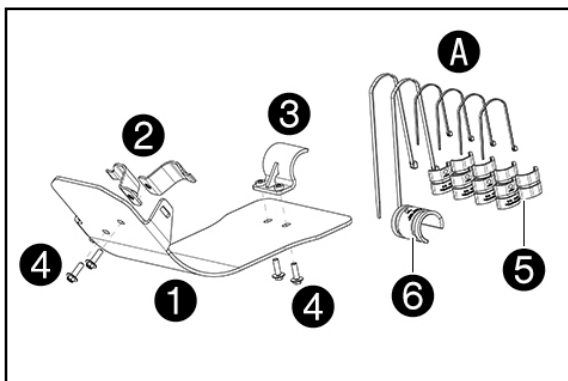

## Contenu de la livraison

- 1x plaque de base de protection moteur ❶
- 2x tôles de fixation ❷
- 1x attache ❸
- 4x vis M6x20 ❹
- 1x kit de tampons en caoutchouc ❶
- 4x petits tampons en caoutchouc ❺
- 1x grand tampon en caoutchouc ❻

### REMARQUE :

Il peut être utile de demander l'aide d'une personne pour ce travail.

## Travaux préalables

- Mettre en place la protection moteur ❶ (fournie).
- Marquer avec un crayon la position du tampon en caoutchouc à gauche et à droite ❷.

### REMARQUE :

Les tampons en caoutchouc servent de logement pour la protection moteur et de support pour la tôle de fixation.

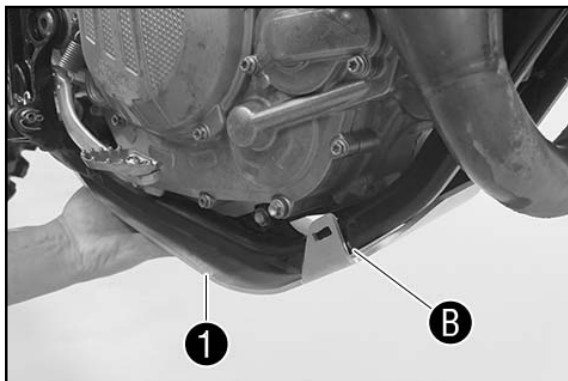

## Montage

- Monter les petits tampons en caoutchouc ❺ avec de petits serre-câbles (tous les éléments sont fournis ❶) à l'avant du cadre.

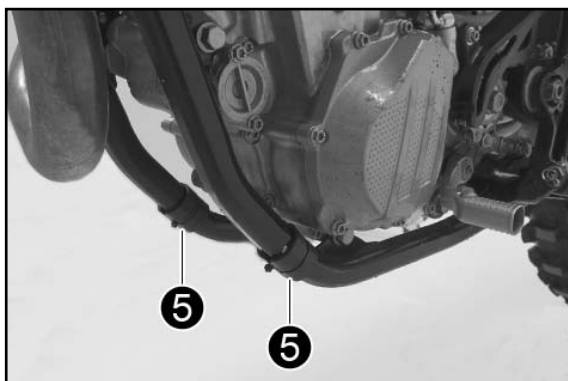

- Monter les petits tampons en caoutchouc ❺ avec des serre-câbles (tous les éléments sont fournis ❶) à l'arrière du cadre.

### REMARQUE :

Ici, le tampon en caoutchouc peut être séparé en deux, car il ne sert que de support pour la protection moteur.

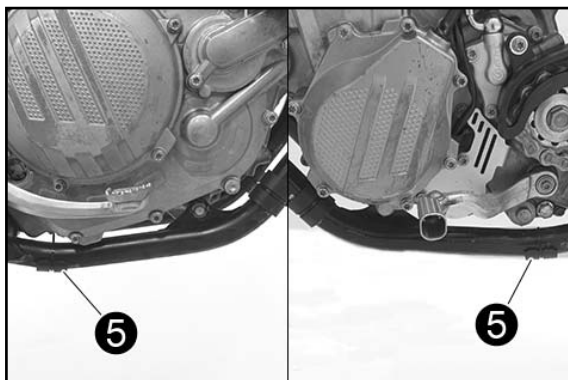

- Monter les grands tampons en caoutchouc ❻ avec de grands serre-câbles (tous les éléments sont fournis ❶) à l'arrière de la traverse intermédiaire.

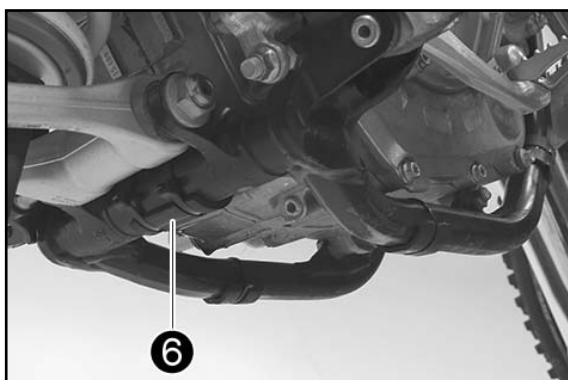

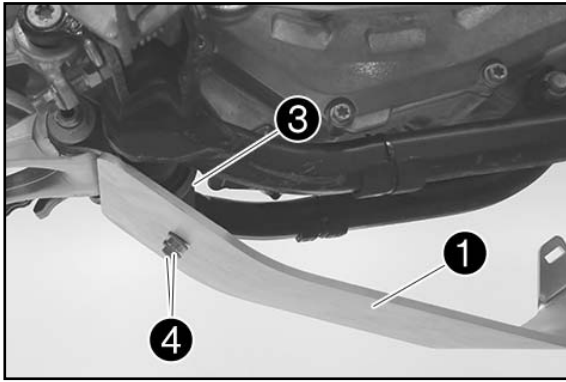

- Mettre en place la protection moteur ① (fournie).
- Positionner l'attache ③ (fournie) sur le tampon en caoutchouc de la traverse intermédiaire.
- Mettre en place les vis ④ (contenu de la livraison) sans les serrer.

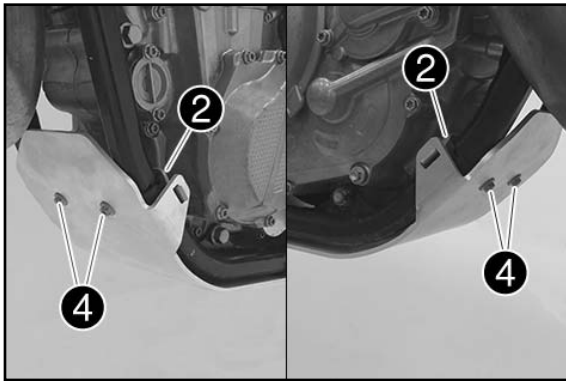

- Accrocher la tôle de fixation à gauche et à droite ② (fournie) et la positionner sur les tampons en caoutchouc avant.
- Mettre en place les vis ④ (contenu de la livraison) et toutes les serrer à 10 Nm.

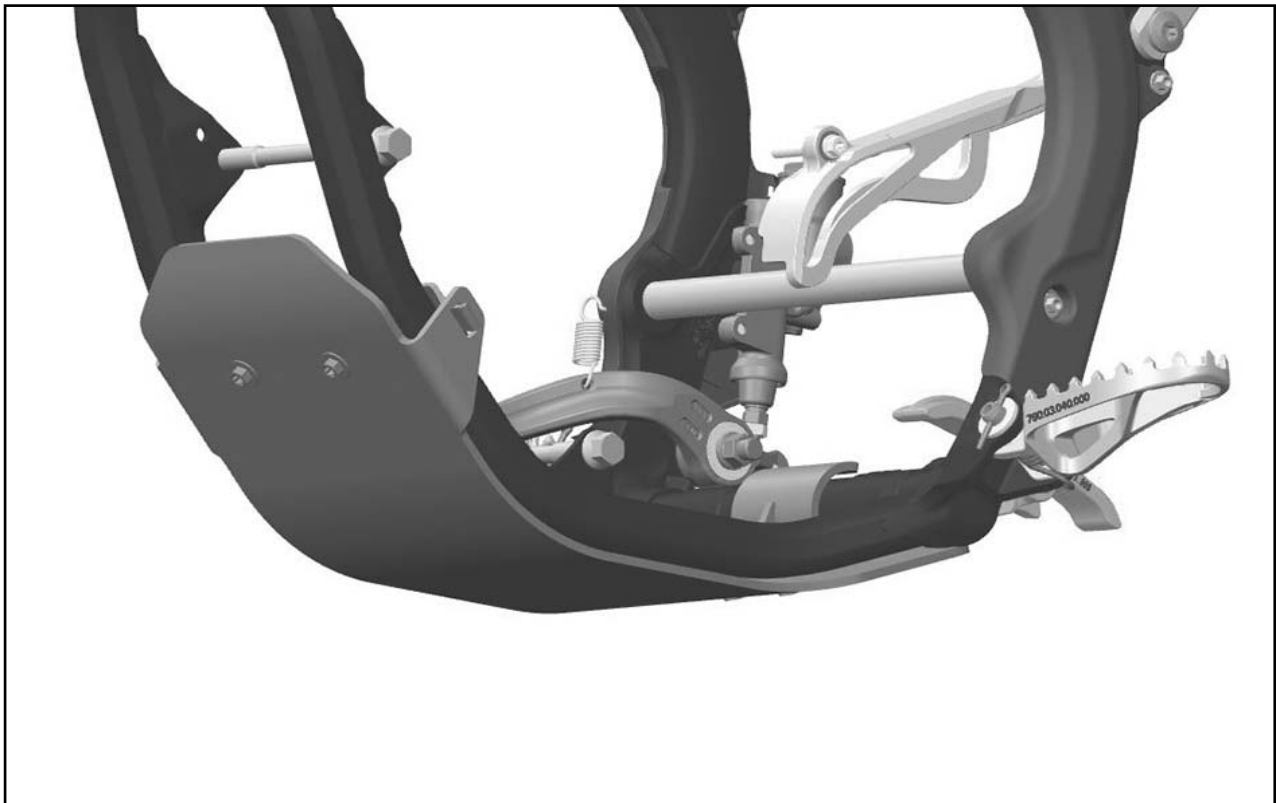

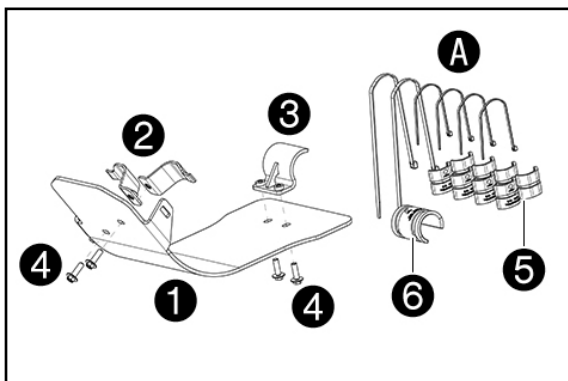

### Volumen de suministro

- 1x placa de montaje para el protector del motor ①
- 2x chapas de sujeción ②
- 1x lengüeta ③
- 4x tornillos M6x20 ④
- 1x kit de topes de goma A
- 4x topes de goma pequeños ⑤
- 1x tope de goma grande ⑥

### ADVERTENCIA:

Esta tarea requiere la ayuda de otra persona.

### Trabajos previos

- Posicionar el protector del motor ① (volumen de suministro).
- Marcar la posición de los topes de goma a la derecha y a la izquierda con un lápiz B.

### ADVERTENCIA:

Los topes de goma sirven como apoyo para el protector del motor y como base para la chapa de sujeción.

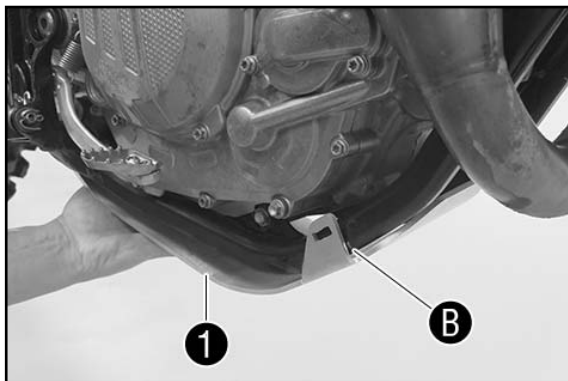

### Montaje

- Montar los topes de goma pequeños ⑤ con cintas sujetacables pequeñas (todo ello incluido en el volumen de suministro A) en la parte delantera del chasis.

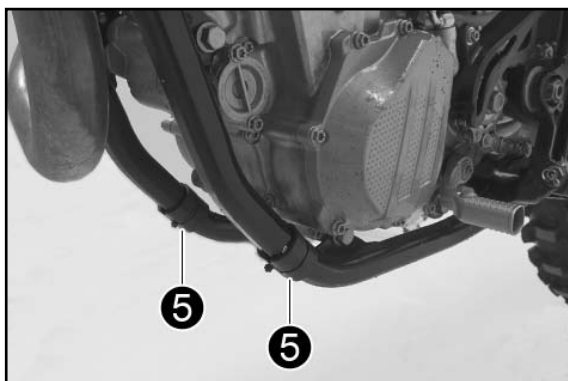

- Montar los topes de goma pequeños ⑤ con cintas sujetacables (todo ello incluido en el volumen de suministro A) en la parte trasera del chasis.

### ADVERTENCIA:

El tope de goma puede dividirse en dos partes aquí, dado que únicamente sirve como apoyo para el protector del motor.

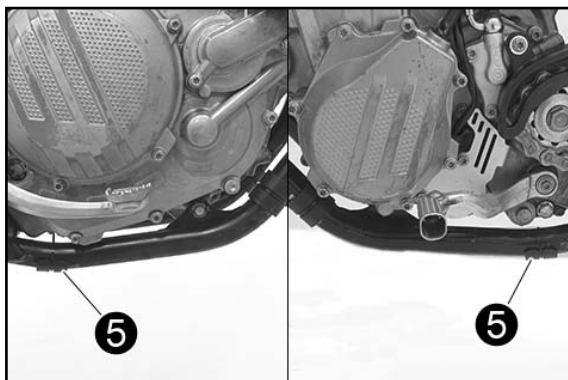

- Montar el tope de goma grande ⑥ con cintas sujetacables grandes (todo ello incluido en el volumen de suministro A) en la parte trasera de la barra transversal.

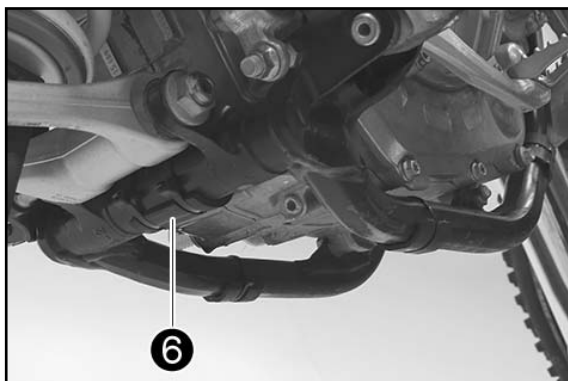

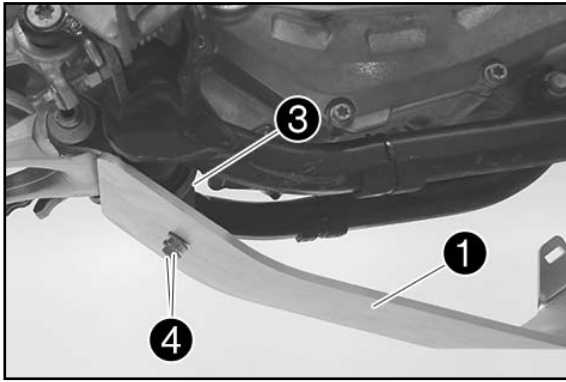

- Posicionar el protector del motor **1** (volumen de suministro).
- Colocar la lengüeta **3** (volumen de suministro) en el tope de goma de la barra transversal.
- Montar los tornillos **4** (volumen de suministro), pero no apretarlos todavía.

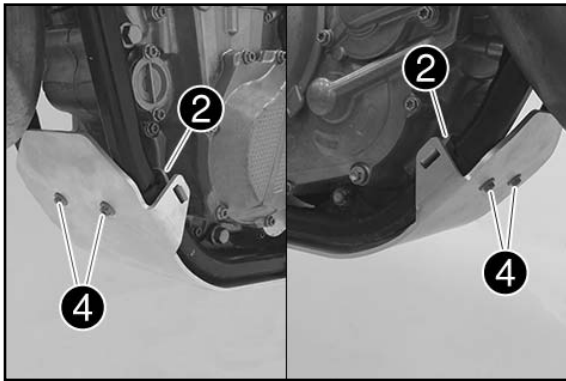

- Enganchar la chapa de sujeción a la derecha y a la izquierda **2** (volumen de suministro) y colocarla en los topes de goma delanteros.
- Montar los tornillos **4** (volumen de suministro) y apretar todos a 10 Nm.

